



# 200W INTEGRATED STEREO HYBRID TUBE AMPLIFIER

Model: HTA200  
User Manual

## Safety Information

### IMPORTANT SAFETY INSTRUCTIONS

To reduce the risk of electric shock, do not remove cover. No user serviceable parts inside. Refer servicing to qualified personnel. To reduce the risk of fire and shock do not expose unit to rain or moisture. The unit should be connected to an earth grounded AC electrical socket. The unit should be operated in a well ventilated area. Minimum clearance is 2 inches from the ventilation openings.



### FCC STATEMENT

1. This device complies with Part 15 of the FCC Rules. Operation is subject to the following two conditions:
  - (a) This device may not cause harmful interference.
  - (b) This device must accept any interference received, including interference that may cause undesired operation.

**NOTE:** This equipment has been tested and found to comply with the limits for a Class B digital device, pursuant to part 15 of the FCC Rules. These limits are designed to provide reasonable protection against harmful interference in a residential installation. This equipment generates uses and can radiate radio frequency energy and, if not installed and used in accordance with the instructions, may cause harmful interference to radio communications. However, there is no guarantee that interference will not occur in a particular installation. If this equipment does cause harmful interference to radio or television reception, which can be determined by turning the equipment off and on, the user is encouraged to try to correct the interference by one or more of the following measures:

- Reorient or relocate the receiving antenna.
- Increase the separation between the equipment and receiver.
- Connect the equipment into an outlet on a circuit different from that to which the receiver is connected.
- Consult the dealer or an experienced radio/TV technician for help.

Changes or modifications not expressly approved by the party responsible for compliance could void the user's authority to operate the equipment.

## Welcome

Thank you for purchasing the Dayton Audio HTA200 Integrated Stereo Hybrid Tube Amplifier. This amplifier has been designed to make it easy for anyone to enjoy the warm, natural sound quality of vacuum tube amplification without the size, power consumption, and price of using traditional tube amplifiers. The HTA series from Dayton Audio achieves this by combining vacuum tubes in the preamp input section with a modern power efficient solid state Class A/B output power amplifier. Additionally, each amplifier includes multiple analog and digital inputs for connecting modern devices such as computers with the classic sound of tube amplifiers.

## Contents

|                                     |    |
|-------------------------------------|----|
| <b>Useful Features</b> .....        | 3  |
| <b>What's In the Box</b> .....      | 3  |
| <b>Controls and Functions</b>       |    |
| Front Panel.....                    | 4  |
| Rear Panel .....                    | 5  |
| Remote Control.....                 | 6  |
| <b>Connections</b>                  |    |
| Connecting Power .....              | 6  |
| Connecting Speakers .....           | 7  |
| Connecting Banana Plug Cables ..... | 7  |
| Connecting Speaker Wires.....       | 7  |
| Connecting A Subwoofer .....        | 7  |
| Connecting Headphones.....          | 7  |
| Connecting Sources .....            | 8  |
| <b>Troubleshooting</b> .....        | 9  |
| <b>Specifications</b> .....         | 10 |
| <b>Warranty</b> .....               | 10 |

## Useful Features

- Phono preamp for connecting turntables without any extra hardware
- Built-in high-quality USB-DAC for direct connection to any computer
- Warm glow from the preamp tubes and front panel controls
- Control the tone with bass and treble knobs
- Remote control and motorized volume knob for easy operation from across the room
- Easily add a subwoofer with the dedicated subwoofer output

## What's In The Box

- HTA200 Integrated Stereo Hybrid Tube Amplifier
- Remote Control
- AC Power Cable
- Bluetooth Antenna
- User Manual

\*Please check to make sure that nothing is missing from the package

# Controls and Functions

## Front Panel

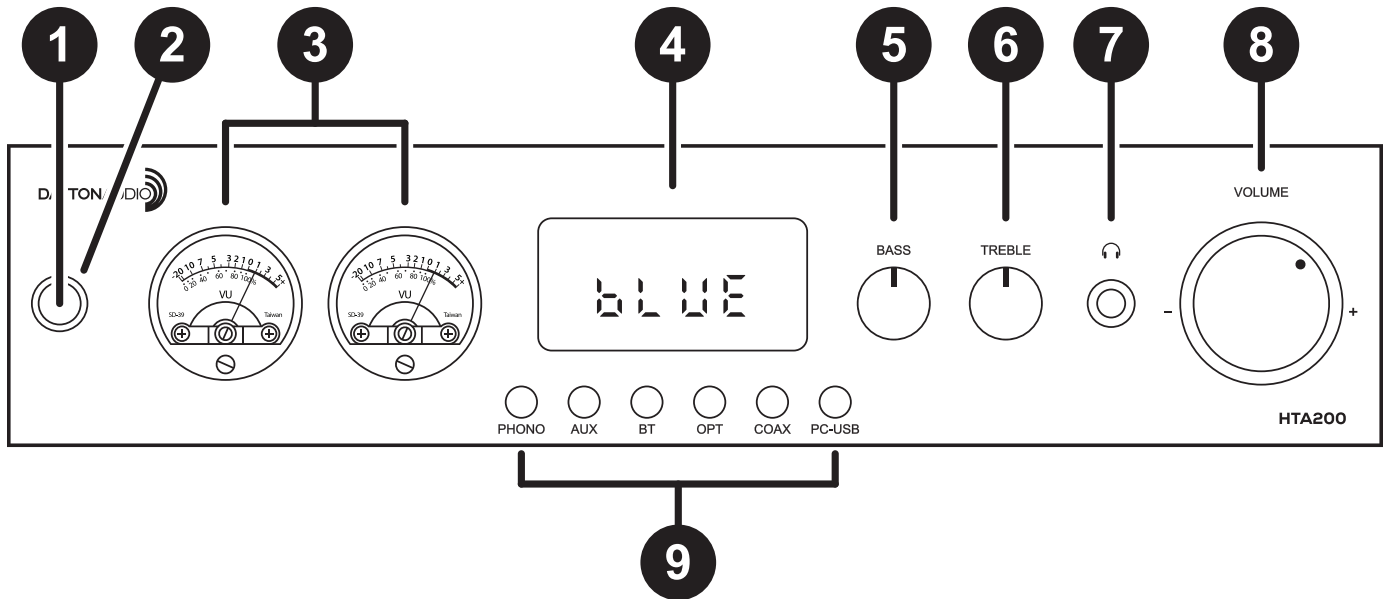

**1. POWER SWITCH/INDICATOR**

Turns the device on and off.

**2. POWER INDICATOR**

The ring surrounding the power switch will illuminate amber when the unit is turned on.

**3. METERS**

Indicates the audio output level of the left and right channels.

**4. DISPLAY**

Indicates the input source.

AUX ..... Aux

BLUE ..... Bluetooth

COAX ..... Coaxial

OPT ..... Optical

PHO ..... Phono

PC ..... PC-USB

----- Mute

**5. BASS CONTROL**

Adjusts the volume level for the bass output.

**6. TREBLE CONTROL**

Adjusts the volume level for the treble output.

**7. HEADPHONE OUTPUT**

The headphone output allows you to listen to any input privately without playing audio through your speakers. The output accepts ¼" TRS headphone connectors. Plugging in headphones here will cut off the signal to the speakers and SW OUT [11].

**NOTE:** To avoid accidental damage to your headphones or speakers always turn down the volume before connecting or disconnecting headphones.

**8. VOLUME CONTROL**

Turn this up to begin experiencing the warm natural tone generated by the tube preamplifier.

**9. SOURCE INPUT SELECTOR**

Press the corresponding input button to select the desired source.

**NOTE:** PC-USB input will not be selectable unless there is a device connected to the unit and powered on.

## Rear Panel

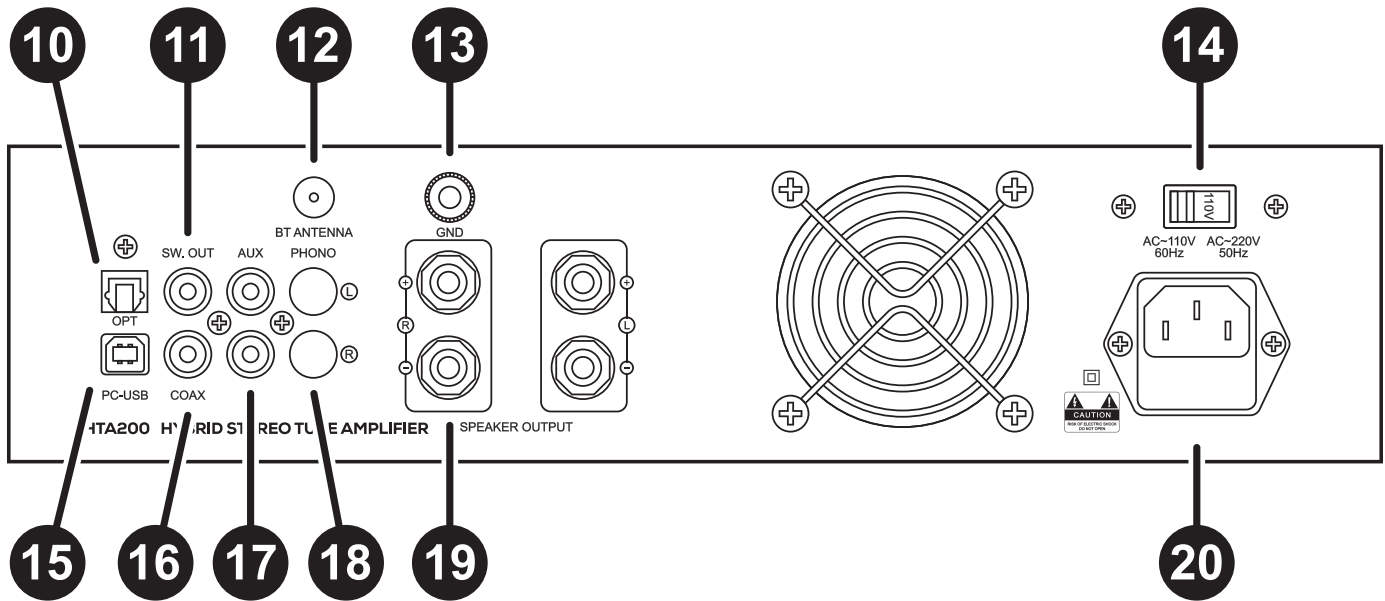

### 10. DIGITAL (OPTICAL) INPUT

### 11. SUBWOOFER OUTPUT

Use a single RCA cable to connect the SW OUT to a powered subwoofer or separate subwoofer amplifier.

This will output a full range mono signal and the volume output will change depending on the position of the front panel volume control.

**NOTE:** The output signal will be interrupted when headphones are connected on the front of the amplifier.

### 12. BLUETOOTH ANTENNA

Connect the supplied Bluetooth antenna here for optimum signal strength.

### 13. GROUND TERMINAL

### 14. AC VOLTAGE SELECTOR SWITCH

The unit is set at the factory for 110V operation. For 220V operation, move the voltage selector switch to the 220V position. When operating at 220V the internal fuse located in the IEC socket should also be changed. In most 220V applications a separate power cord will be required and is not included.

### 15. PC-USB INPUT

### 16. DIGITAL (COAXIAL) INPUT

### 17. LINE LEVEL (AUX) INPUT

### 18. PHONO INPUT

### 19. SPEAKER OUTPUTS

Using insulated 2 conductor wire to connect to speakers. The polarity, positive (+), and negative (-) for all speaker and amplifier connections must be consistent so both the left and right speakers are in phase.

**NOTE:** The speaker outputs are not bridgeable.

### 20. AC POWER INPUT

## Remote Control

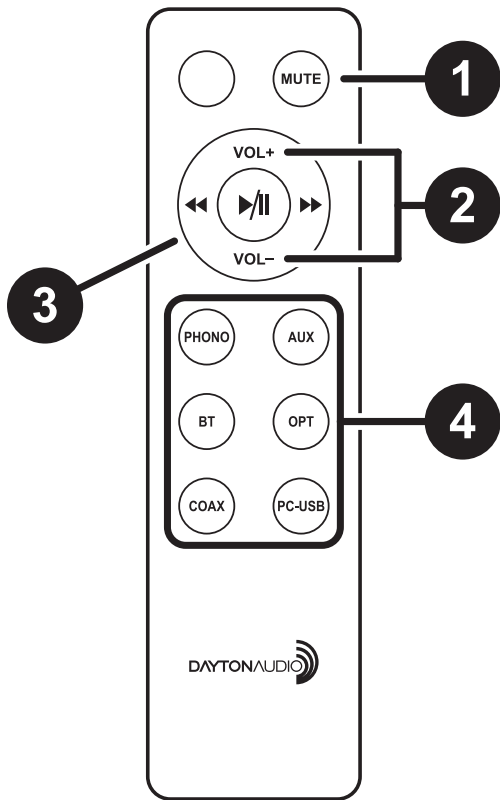

- 1. MUTE**
  1. When muted, the HTA200 will display ---- on it's screen.
- 2. VOLUME +/-**
  1. Control the volume of the amplifier. The volume knob will rotate to indicate the current level of the amplifier.
- 3. TRACK TRANSPORT CONTROLS**
  1. Control the playback of the Bluetooth input.
  2. "play/pause logo" – start/pause the current song.
  3. "forward logo" – skip forward to the next song.
  4. "backward logo" skip backward to the beginning of the current song or the previous song.
- 4. INPUT SELECTION**
  1. Directly select any of the inputs here.
  2. **NOTE:** PC-USB is only selectable when a device is connected to the USB port on the rear of the unit.

## Connections

### Connecting the Power Cable

Before connecting the main power cable, make sure that the voltage selector switch is set according to your local voltage. Incorrect setting of the voltage selector switch could cause damage to the amplifier and has a potential risk of fire.

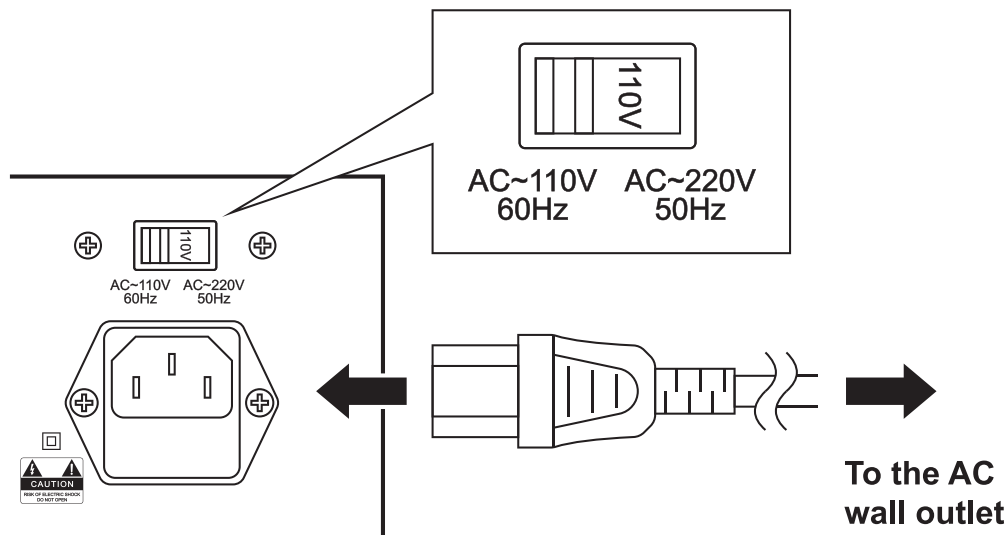

## Connecting Speakers

The amplifier can power speakers with a minimum impedance of 4Ω. Using high quality two conductor speaker wire connect your speakers to the binding posts on the rear of the unit.

Connect the HTA200's left speaker terminals marked "L-" and "L+" to the corresponding "-" and "+" terminals on your left speaker. Repeat the same process for the right channel.

**Note:** Never connect the negative terminals together or to ground. The HTA200 is not designed to operate in a bridged mode and attempting to do so may damage the amplifier.

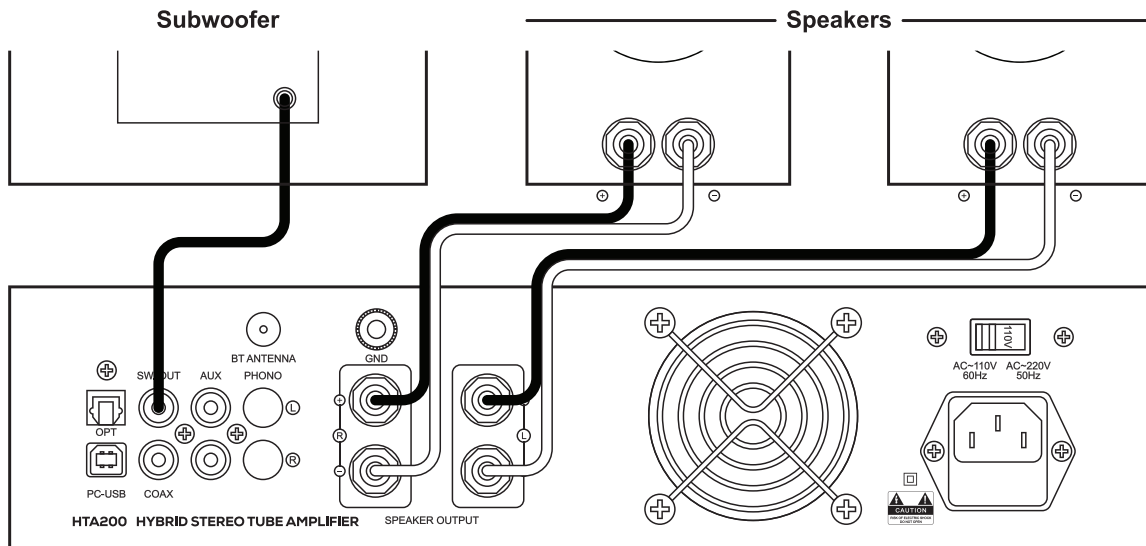

## Connecting Banana Plug Cables

1. Tighten the knob.
2. Insert the banana plug terminated cable into the end of the corresponding terminal.

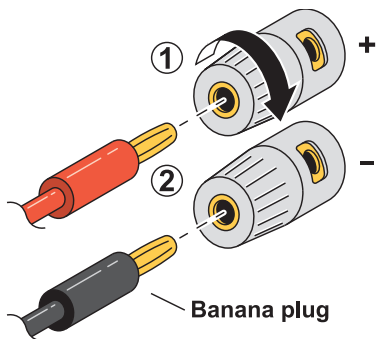

## Connecting Speaker Wires

1. Strip about 3/8" of insulation from the end of each speaker wire and twist the bare wires of the cable together.
2. Unscrew the knob before inserting the bare wire into the hole in the side of each terminal before tightening the knob to secure the wire.

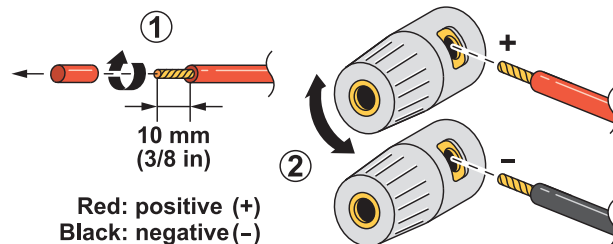

## Connecting A Subwoofer

If you really want to feel the bass or just want to bother the neighbors you can add a subwoofer using the SW OUT connection on the rear of the HTA200. This signal is full range and will send a mono summed signal that is controllable by the front volume knob. Using a single RCA cable you can connect to the line level input on a powered subwoofer or to any external subwoofer amplifier to power passive subwoofers.

## Connecting Headphones

Headphones can be connected to the 1/4" TRS connection on the front of the HTA200. This is great for listening to any source and enjoying the classic warmth from the tube preamps. Plugging in headphones will stop any signal from being output to the speaker output terminals or SW OUT.

**Note:** To avoid damage to headphones or your hearing make sure to turn down the volume before plugging in your headphones. Always turn down the volume knob before unplugging headphones to avoid accidental output to your speakers or startling any cats napping nearby.

## Connecting Sources

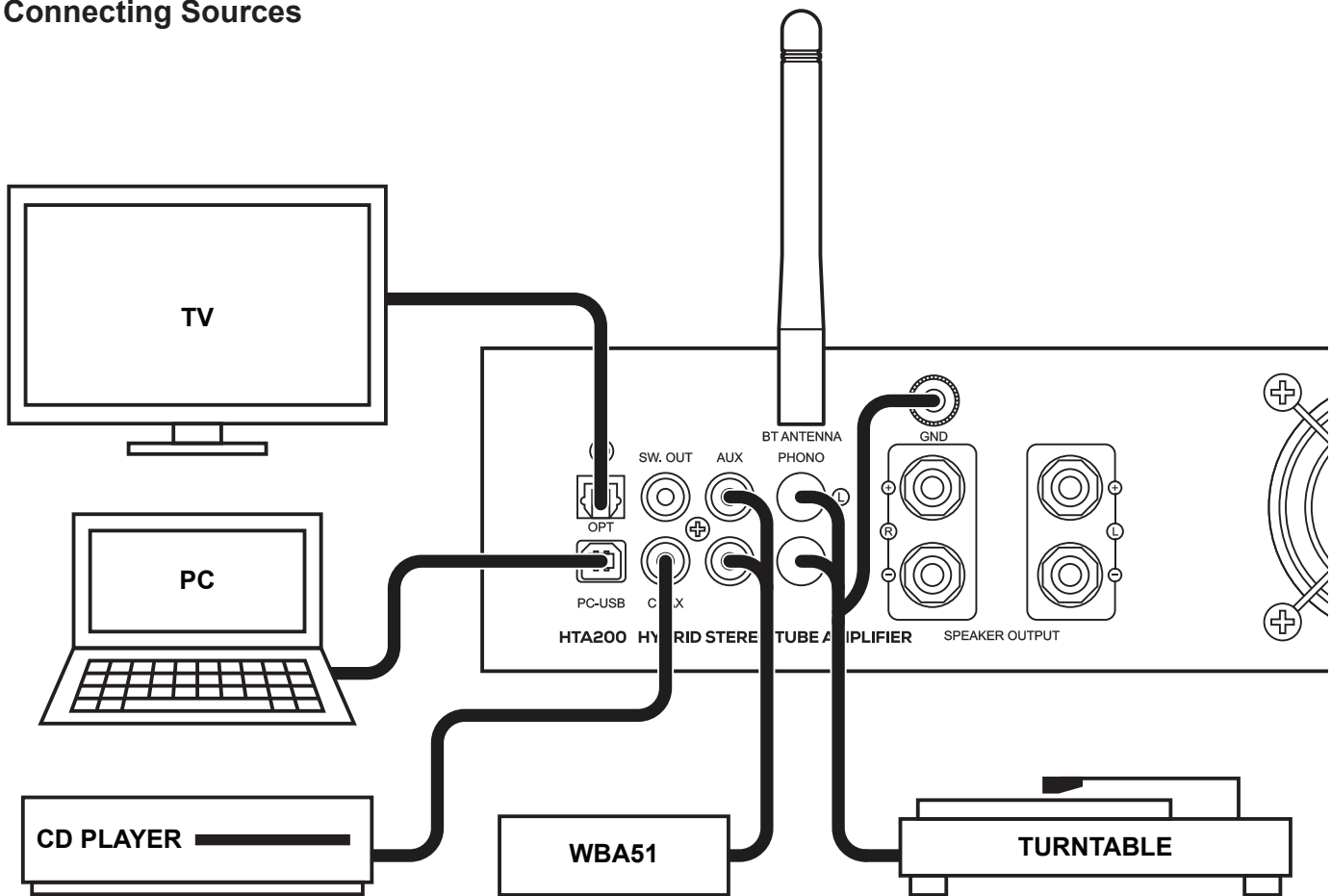

The HTA200 is capable of receiving signals directly from a wide variety of sources. Using high quality cables will ensure the best possible transmission from your connected devices.

### Connecting a Turntable

The HTA200 is capable of connecting directly to most turntables without the addition of an external phono preamplifier.

1. Ensure that your turntable is set to output a phono signal. Many modern turntables have the ability to output either a line level signal or a phono signal. If your turntable is set to output a line level signal please connect it to the AUX input on the HTA200.
2. Remove the covers from the PHONO RCA plugs and connect the turntable to the phono input.
3. Connect the ground wire of the turntable to the ground terminal on the rear of the HTA200 (if applicable).

### Bluetooth as a Source

1. Connect the Bluetooth antenna to the BT ANTENNA port on the rear of the unit. Also make sure that the Bluetooth input is selected on the HTA200.
2. Using a smart phone, tablet, computer, or other device capable of transmitting Bluetooth audio, go to the device's settings and scan for available Bluetooth devices.
3. Look for and select "HTA200" in the device list and begin pairing. The front display panel on the HTA200 will flash until a device is paired.
4. Once the front display panel stops flashing and your device indicates that you are connected you can begin streaming your favorite music from up to 30 feet away.



## Troubleshooting

| Problem                     | Cause   | Solution   |
|-----------------------------|---|--|
| The unit fails to turn on   | The power cable is not connected properly                               | Check to make sure both ends of the power cable are connected properly.  |
|                             | Incorrect voltage selection switch setting                              | Verify that the voltage selection switch is set according to the region and power standard in your country.  |
|                             | Protection circuit has been activated                                   | Turn the amplifier off and check that your speaker wires are not shorting out. If this problem persists please contact Dayton Audio for customer support.  |
| The unit turns off suddenly | There is a short in the connected speaker wire.                         | Examine the speaker wire for any damage. Do not use any cable that has exposed wire.   |
|                             | Speaker malfunctioning  | Disconnect the speakers one at a time to see if the issue is caused by the speakers or the amplifier. If the problem persists with all speakers please contact Dayton Audio customer support.                  |
| No sound                    | The output is muted   | The amplifier can only be muted and unmuted from the provided remote. Press "Mute" on the remote control. If you cannot find the remote, turning the amplifier off and back on again will unmute the output.   |
|                             | Correct input has not been selected                                     | Verify that the correct input is selected.   |
|                             | Headphones are connected  | Unplug the headphones from the front panel. Audio should resume in the connected speakers.   |
|                             | Incorrect cable connections   | Double check that the device that you are trying to listen to is connected to the correct input.   |
| Low volume                  | Volume on the playback device is turned down                            | Verify that any volume control on your phone, computer, or connected playback device is turned up.   |
| The sound output lacks bass | The speakers polarity is reversed                                       | Double check the speaker connections, ensuring that the + and - terminals are connected properly on both speakers. (p.7)   |
|                             | The bass knob is turned down  | Ensure that the "BASS" control knob is not turned down all the way.  |
| There is a "humming sound"  | No ground connection from the amplifier to the turntable                | Make sure that the GND connection is made between the turntable and the amplifier.   |
| The turntable is distorted  | The turntable is set to line output but is connected to the PHONO input | Verify that if your turntable is using a line out signal that it is connected to the AUX input on the amplifier. If the turntable is outputting a phono signal verify that it is connected to the PHONO input. |
|                             | The phono connection is improperly grounded                             | Make sure that there is a connection between the grounding terminals on the amplifier and the turntable.   |

## Specifications

|  |                                |
|--|--------------------------------|
| <b>Maximum Power Output (Peak)</b> ..... | 140W x 2 @ 4 Ohm               |
| <b>RMS Power Output</b> .....            | 100W x 2 @ 4 Ohm               |
| <b>Total Gain</b> .....                  | 29 dB                          |
| <b>THD+N</b> .....                       | <1.5% @ Maximum Rated Output   |
| <b>Frequency Response</b> .....          | 15 Hz – 20,000 Hz (1 dB)       |
| <b>Input Sensitivity</b> .....           | 1.0 V                          |
| <b>Channel Separation</b> .....          | 53 dB                          |
| <b>Minimum Speaker Impedance</b> .....   | 4 Ohm                          |
| <b>Tone Controls – Bass/Treble</b> ..... | 6 dB/oct @ 200 Hz and 4,000 Hz |
| <b>Signal To Noise Ratio</b> .....       | 80 dB                          |

## Digital Section

|                             |                                  |
|-----------------------------|----------------------------------|
| <b>Digital Inputs</b> ..... | SPDIF LPCM (up to 48 kHz 16 Bit) |
| <b>PC-USB</b> .....         | up to 192 kHz 32 Bit             |
| <b>Bluetooth</b> .....      | 5.0                              |

## General

### Power Requirement

|          |             |
|----------|-------------|
| USA..... | 110V, 60 Hz |
| EC.....  | 220V, 50 Hz |

|  |  |
|--|--|
| <b>Standby Power Consumption</b> ..... | 45W  |
| <b>Preamplifier Tubes</b> .....        | 13P1P x 2, 6H2 x 2, 6A2 x 2                      |
| <b>Stabilivolt Tube</b> .....          | WY3P   |
| <b>Amplification</b> .....             | Class A/B  |
| <b>Dimensions (W, H, D)</b> .....      | 13-1/8 x 6-1/2 x 12-1/2 in. (333 x 165 x 318 mm) |
| <b>Weight</b> .....                    | 16.4 lbs. / 7.44 kg                              |

All Specifications are accurate at the time of printing.  
Dayton audio reserved the right to make improvements without notice.

## Warranty

Dayton Audio products are warranted to be free of all defects in material and workmanship for 5 YEARS from the date of purchase from an authorized Dayton Audio dealer. This warranty and all rights provided are limited to the original owner and are non-transferable. Responsibility is limited to replacement or repair as set forth in this warranty statement.

Should a product require warranty service during this period, Dayton Audio will repair or replace without charge, any part or product proving defective in material or workmanship. All warranty repairs and service must be performed by an authorized Dayton Audio technician or service facility. The use of non-authorized repair services renders this warranty null and void, and any charges relating to non-authorized repair are the responsibility of the product owner. All expenses (except return shipping costs) related to replacing or repairing a defective part or product under this warranty shall be assumed by Dayton Audio. Dayton Audio reserves the right to replace defective product with a new or factory reconditioned unit.

For more information and to register your new Dayton Audio device visit [daytonaudio.com](http://daytonaudio.com).

## Notes

Purchased on: \_\_\_\_\_



Dayton Audio®

**5-Year Limited Warranty**

See [daytonaudio.com](http://daytonaudio.com) for details

[daytonaudio.com](http://daytonaudio.com)  
tel + 937.743.8248  
[info@daytonaudio.com](mailto:info@daytonaudio.com)

705 Pleasant Valley Dr.  
Springboro, OH 45066  
USA



Last Revised: 04/06//2023